

ART. 204.WDxxx

MONTAGGIO / MOUNTING / MONTAGE / MONTAJE

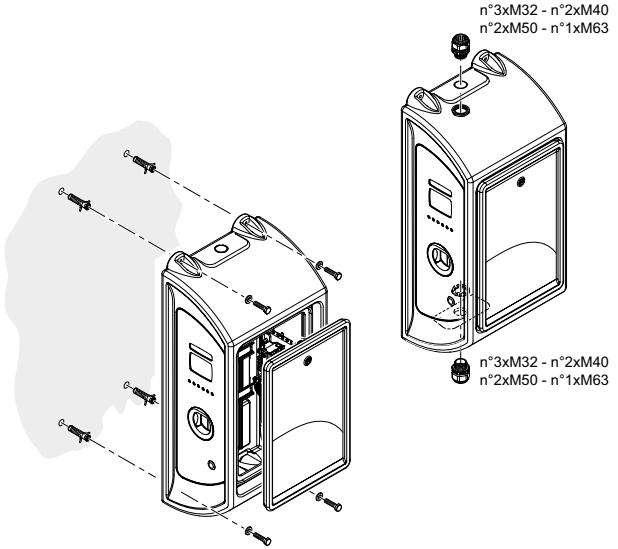
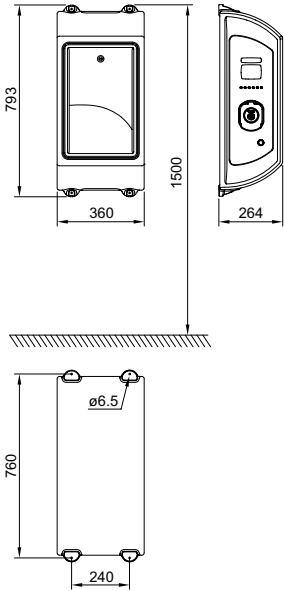

CABLAGGIO / WIRING / CÂBLAGE / CABLEADO

L-L: 380 ÷ 400 Vac
 L-N: 220 ÷ 230 Vac
 N-PE : < 5 Vac
 f: 50/60 Hz
 Rt: < 150 Ω
 THD: < 8%

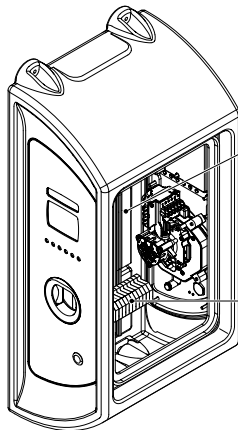

SERIAL LINE



0,5 mm²
 ES. BELDEN 9841

TCP/IP LINE



RJ45
 CAT5

POWER SUPPLY

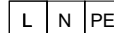

2,5+35 mm²

OR

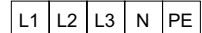

2,5+35 mm²

(dimensioni in mm) / (dimensions in mm)
 (dimensiones en mm) / (dimensiones en mm)

FUNZIONAMENTO / WORKING / FONCTIONNEMENT / OPERACIÓN

FREE

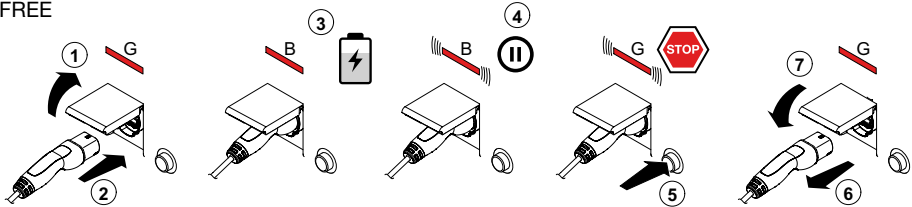

PERSONAL

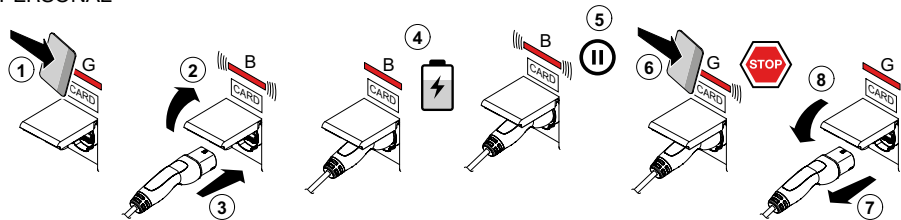

G: GREEN

B: BLUE

CAMBIO MODALITA'

Personal → Free

Con pulsante premuto, passare carta master su lettore.

Free → Personal

Con pulsante premuto, passare carta master su lettore.

CHANGE MODE

Personal → Free

With button pressed down, switch the master card on reader.

Free → Personal

With button pressed down, switch the master card on reader.

CHANGEMENT DE MODE

Personal → Free

Avec le bouton enfoncé, passez la fiche mère en fonction lecteur.

Free → Personal

Avec le bouton enfoncé, passez la fiche mère en fonction lecteur.

CAMBIO DE MODO

Personal → Free

Con el botón presionado, cambiar la tarjeta maestra a lector.

Free → Personal

Con el botón presionado, cambiar la tarjeta maestra a lector.

NOTE / NOTES / NOTES / NOTAS

Questo apparecchio deve essere installato e sottoposto a manutenzione da personale qualificato.

This device shall be installed and maintained by qualified personnel.

Cet appareil doit être installé et entretenu par du personnel qualifié.

Este aparato debe ser instalado y mantenido por personal calificado.

Il costruttore non può essere ritenuto responsabile del mancato rispetto delle presenti istruzioni.

The manufacturer can not be held responsible for any failure to comply with these instructions.

Le fabricant ne peut être tenu responsable du non-respect de ces instructions.

El fabricante no se hace responsable por el incumplimiento de estas instrucciones.

Per scaricare il manuale d'uso delle stazioni di ricarica visitate il nostro sito web:

To download the user manual of charging stations visit our website:

Pour télécharger le manuel d'utilisation des bornes de recharge, visitez notre site web:

Para descargar el manual del usuario de las estaciones de carga, visite nuestro sitio web:

<https://www.emobility-scame.com/web/ita/download>



InfoTECH

ITALY

Numero Verde
800-018009

WORLDWIDE

ScameOnLine
www.scame.com
e-mobility@scame.com